



kitchen think

Instructions for Installation and Use

Washing machine
Model AQXXF 149 PI

To the Installer

Before installation fill in the product details on the back cover of this book.
The information can be found on the rating plate.

To the User

You must read the instructions prior to installing and using the appliance and
then retain them for future reference.

GB

English,1

AQXXF 149 PI

Contents

Installation, 2-3-4-5

Unpacking and levelling
Connecting the cold water and electricity supplies
Technical data

Description of the machine, 6-7

Control panel

Running a wash cycle,8

Programmes and options, 9

Table of Programmes
Wash options

Detergents and laundry, 10

Detergent
Preparing the laundry
Washing advice
Load-balancing system

Precautions and tips, 11

General safety
Disposal
Opening the door manually

Care and maintenance, 12

Turning off the water and electricity supplies
Cleaning the machine
Cleaning the detergent dispenser
Drum maintenance
Cleaning the pump
Checking the water inlet hose

Troubleshooting, 13

Assistance, 14

GB

Installation

GB

! Keep this instruction manual in a safe place for future reference. If the appliance is sold, given away or moved, please ensure the manual remains with the machine so that the new owner may benefit from the advice contained within it.

! Please read this instruction manual carefully it contains important information regarding the safe installation, use and maintenance of the appliance.

! You will find the guarantee and other details relating to the installation process in the bag containing this booklet.

Unpacking and levelling

Unpacking

1. Once the washing machine has been removed from the packaging, check that it has not been damaged during transportation.

If it has been damaged, contact the retailer and do not proceed any further with the installation process.

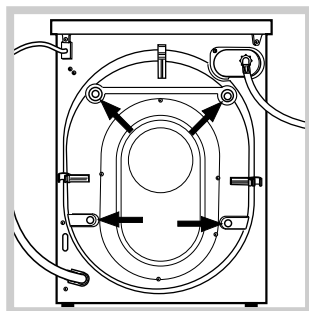

2. Remove the four transit bolts and the rubber bush with the respective spacer, situated on the rear of the appliance.

NB: The plastic spacers may fall down inside the machine once the bolt has been removed, and

will not interfere with the operation of the machine.

3. Having removed the 4 bolts use the 4 plastic blanking plates to cover the 4 holes.

4. Keep all the pieces; if the washing machine is transported in future, the transit bolts and spacers will have to be replaced in order to avoid damaging the inside of the machine.

! Packaging materials should not be used as toys by children.

Levelling

1. Position the washing machine on a level and sturdy floor, without resting it against walls or cabinets.

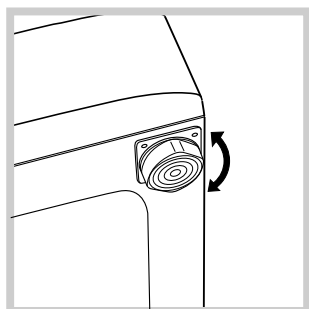

2. If the floor is uneven, the feet of the appliance may be adjusted until it reaches a perfectly horizontal position (the angle of inclination must not exceed 2 degrees).

! If the appliance is levelled correctly it will be more stable and much less likely to cause vibrations and noise during the spin cycle.

! If positioned on a fitted carpet or a rug, adjust the feet in such a way as to allow room for air to circulate and provide ventilation beneath the washing machine.

Connecting the cold water and electricity supplies

Connecting the water inlet hose

! Before connecting the inlet hose to the cold water supply, allow the water to flow from the tap until it runs clear.

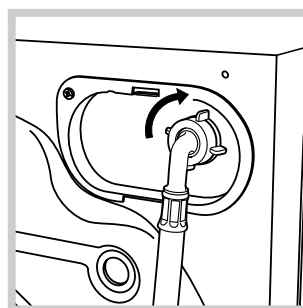

1. Connect the inlet hose to the machine, by screwing it into the cold water inlet on the upper right hand side of the back of the machine (see figure).

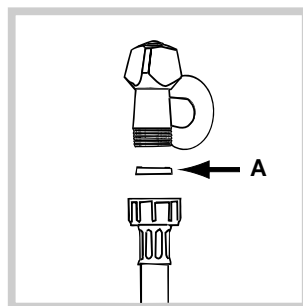

2. Place the seal A (provided in the bag) on the end of the inlet hose and screw it to a cold water tap with a 3/4 BSP threaded connection (see figure).

3. Make sure there are no kinks or bends in the inlet hose.

! The water pressure at the tap must fall within the values indicated in the Technical data table (see next page).

! If the water inlet hose is not long enough, contact a specialist store or an authorised technician.

! Always use the new water inlet hoses supplied with the machine.

Drainage Connection

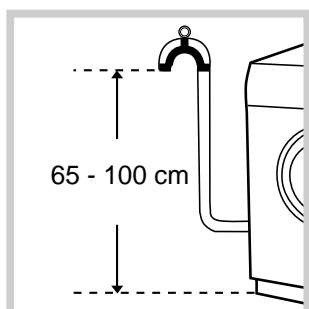

Connect the drain hose, without kinking it, to a draining duct or a stand pipe situated between 65 and 100 cm from the floor;

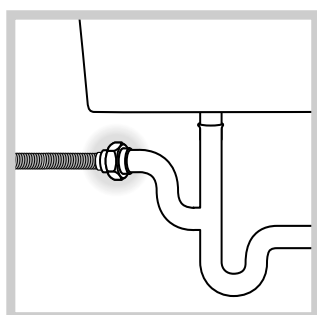

The drain hose may be connected to an under-sink trap. Before connecting the drain hose from the machine ensure that any blanks or removable ends have been taken off the spigot.

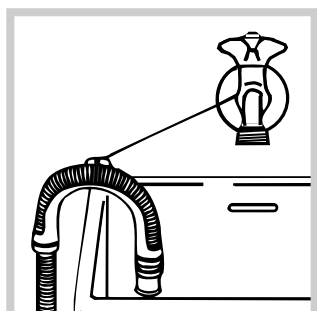

If it is placed over the edge of a basin or sink be sure the free end of the hose should not be underwater.

! We advise against the use of hose extensions; in case of absolute need, the extension must have the same diameter as the original hose and must not exceed 150 cm in length.

Ensure that if the drain hose is pushed into a standpipe, that the end does not go down more than 15cms (6 inches). If the hose is pushed down too far, this may cause the machine to self-siphon ie. continuously empty as it is filling.

Electric connection

Before plugging the appliance into the mains socket, make sure that:

- the socket is earthed and in compliance with the applicable law;
- the socket is able to sustain the appliance's maximum power load indicated in the Technical details table *(on the page 5)*;

- the supply voltage is included within the values indicated on the Technical details table *(on the page 5)*;
- the socket is compatible with the washing machine's plug. If this is not the case, replace the socket or the plug.

Your appliance is now supplied with a 13 amp fused plug it can be plugged into a 13 amp socket for immediate use. Before using the appliance please read the instructions below.

WARNING - THIS APPLIANCE MUST BE EARTHED. THE FOLLOWING OPERATIONS SHOULD BE CARRIED OUT BY A QUALIFIED ELECTRICIAN.

Replacing the fuse:

When replacing a faulty fuse, a 13 amp ASTA approved fuse to BS 1362 should always be used, and the fuse cover re-fitted. If the fuse cover is lost, the plug must not be used until a replacement is obtained.

Replacement fuse covers:

If a replacement fuse cover is fitted, it must be of the correct colour as indicated by the coloured marking or the colour that is embossed in words on the base of the plug. Replacements can be obtained directly from your nearest Service Depot.

Removing the plug:

If your appliance has a non-rewireable moulded plug and you should wish to re-route the mains cable through partitions, units etc., please ensure that either:

the plug is replaced by a fused 13 ampere re-wearable plug bearing the BSI mark of approval. or:

the mains cable is wired directly into a 13 amp cable outlet, controlled by a switch, (in compliance with BS 5733) which is accessible without moving the appliance.

Disposing of the plug:

Ensure that before disposing of the plug itself, you make the pins unusable so that it cannot be accidentally inserted into a socket.

Instructions for connecting cable to an alternative plug:

Important: the wires in the mains lead are coloured in accordance with the following code:

Green & Yellow	Earth
Blue	Neutral
Brown	Live

As the colours of the wires in the lead may not correspond with the coloured markings identifying the terminals in your plug, proceed as follows:
 Connect Green & Yellow wire to terminal marked **E** or \perp or coloured Green or Green & Yellow.
 Connect Brown wire to terminal marked **L** or coloured Red.
 Connect Blue wire to terminal marked **N** or coloured Black.

If a 13 amp plug (BS 1363) is used it must be fitted with a 13 amp fuse, either in the plug or adaptor or at the distribution board.

If you are in any doubt the electrical supply to your machine, consult a qualified electrician before use.

How to connect an alternative plug:

The wires in this mains lead are coloured in accordance with the following code:

BLUE	NEUTRAL (N)
BROWN	LIVE (L)
GREEN & YELLOW	EARTH (E)

Disposing of the appliance:

When disposing of the appliance please remove the plug by cutting the mains cable as close as possible to the plug body and dispose of it as described above.

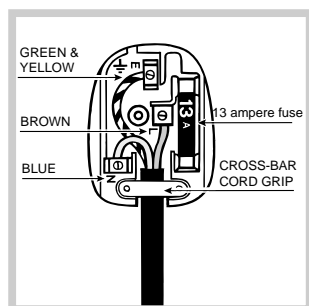

! The washing machine should not be installed in an outdoor environment, not even when the area is sheltered, because it may be very dangerous to leave it exposed to rain and thunderstorms.



! When the washing machine is installed, the mains socket must be within easy reach.

! Do not use extensions or multiple sockets.

! The power supply cable must never be bent or dangerously compressed.

! The power supply cable must only be replaced by an authorised serviceman.

Warning! The company denies all liability if and when these norms are not respected.

Technical data	
Model	AQXXF 149 PI
Dimensions	width 59.5 cm height 85 cm depth 64.5 cm
Capacity	from 1 to 7.5 kg
Electrical connections	voltage 220-240 V 50 Hz maximum absorbed power 2100 W
Water connections	maximum pressure 1 MPa (10 bar) minimum pressure 0.05 MPa (0.5 bar) drum capacity 62 litres
Spin speed	up to 1400 rotations per minute
Energy rated programmes according to regulation IEC456	WHITES programme; temperature 60°C; using a load of 7.5 kg.
 	This appliance conforms to the following EC Directives: - 72/23/EEC dated 19/02/73 (Low Voltage) and subsequent modifications - 89/336/EEC dated 03/05/89 (Electromagnetic Compatibility) and subsequent modifications - 2002/96/EC

Description of the machine

GB

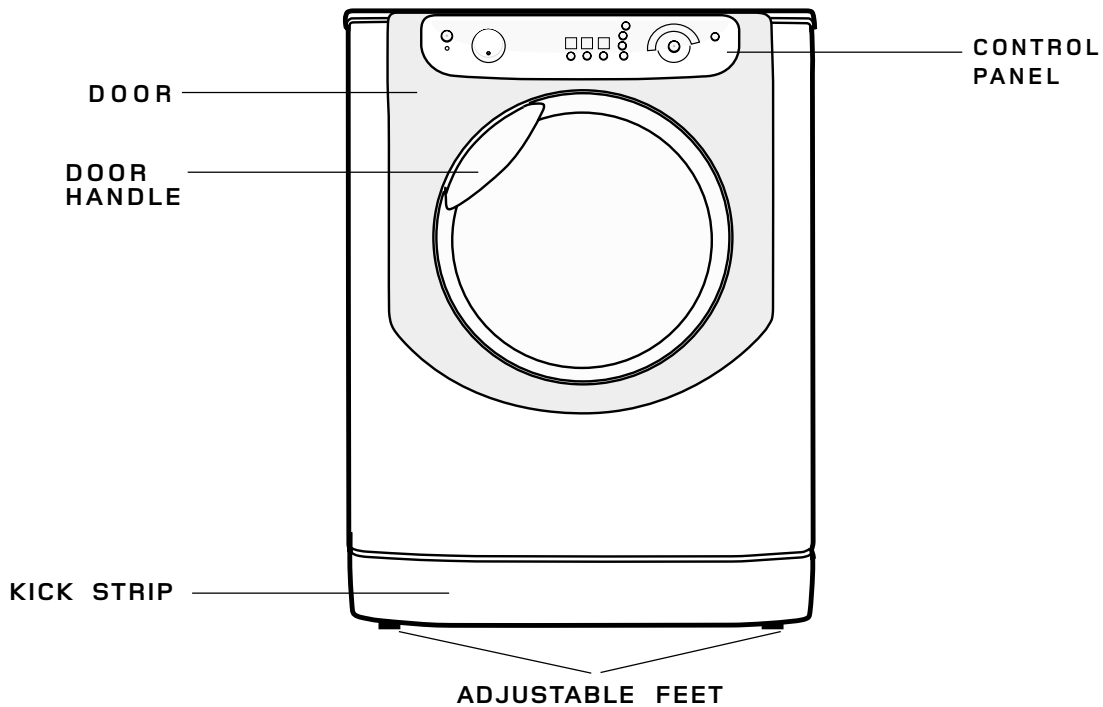

DOOR



Always use the handle to open the door (*see figure*).

DETERGENT DISPENSER:

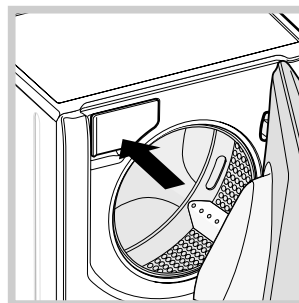

This is inside the machine and may be accessed by opening the door.

For information relating to detergents, please refer to the chapter entitled "*Detergents and laundry*".

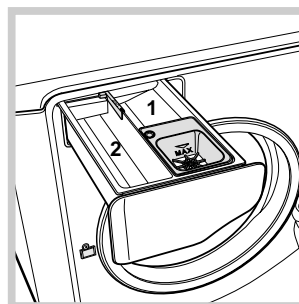

1. pre-wash compartment: use powder detergent.
2. main wash compartment: use powder or liquid detergent. If you intend to use liquid detergent, we recommend that it is poured into the

compartment immediately before the wash cycle is started.

☼ *compartment for additives*: for fabric softener or other liquid washing additives. Do not exceed the maximum level indicated by the grille, and dilute concentrated fabric softeners.

Control panel

GB

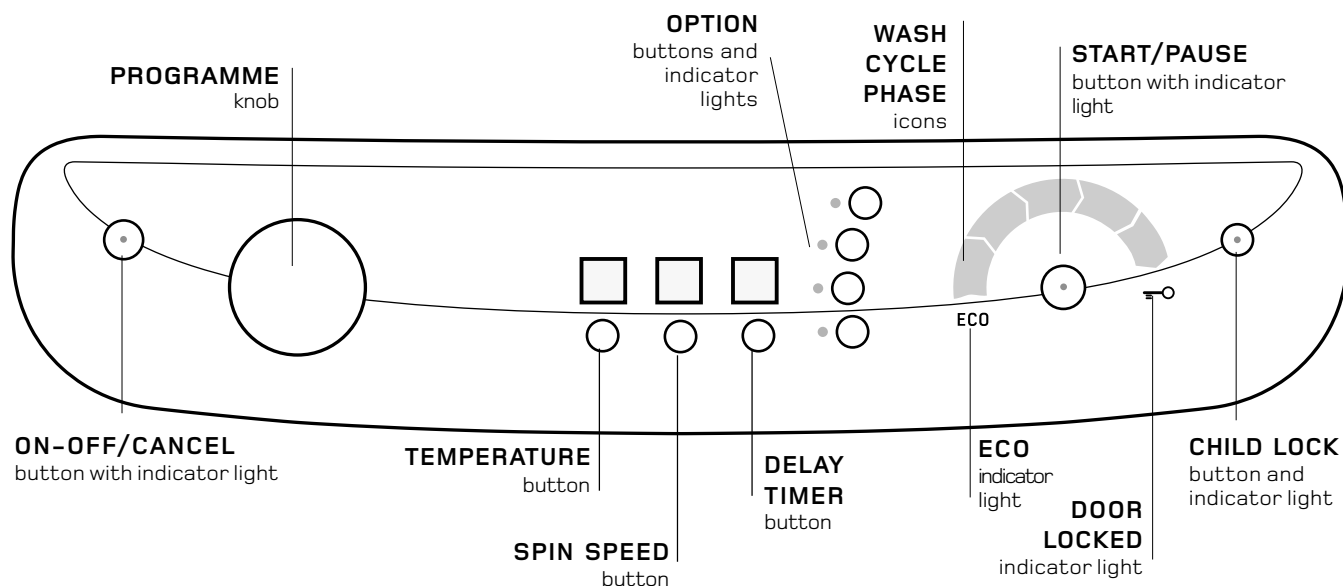

ON-OFF/CANCEL button with indicator light : press the button briefly to switch the machine on or off. The green indicator light shows that the machine is switched on. To switch the washing machine off during a wash cycle, press and hold the button for approximately 2 seconds; pressing the button quickly or accidentally will not switch the machine off. If the machine is switched off during a wash cycle, the programme will be cancelled.





PROGRAMME knob: this can be rotated in both directions. To set a more suitable programme, please refer to the "Table of Programmes". The knob is locked into position during the wash cycle.

TEMPERATURE  button: press this button to adjust the temperature; the value will be identified by the display above (see "Running a wash cycle").

SPIN SPEED  button: press this button to adjust the spin value or to exclude this part of the programme; the value will be identified by the display above (see "Running a wash cycle").

DELAY TIMER  button: press to set a delayed start time for the selected programme; the delay time will be identified by the display above (see "Running a wash cycle").

OPTION buttons and indicator lights: may be used to select any of the available options. The indicator light corresponding to the selected option will remain lit (see "Running a wash cycle").

WASH CYCLE PHASE icons: these light up to provide an indication of the progress of the wash cycle (Wash  - Rinse  - Spin  - Pumpout ). The text **END** lights up when the cycle has finished.

START/PAUSE button with indicator light: when the green indicator light flashes slowly, press the button to start the wash cycle. When the cycle has started, the indicator light is illuminated in a fixed manner. To pause the wash cycle, press the button again; the indicator light will turn orange and begin to flash again. If the "Door Locked"  indicator light is off, the porthole door may be opened. To restart the wash cycle from the point at which it was interrupted, press the button again.

DOOR LOCKED  indicator light: this indicates that the porthole door is locked. To open the door, pause the wash cycle (see following page).



CHILD LOCK  button and indicator light: this is used to enable or disable the "Child lock" function, by pressing the button for approximately 2 seconds. When the indicator light is illuminated, the control panel is locked. This avoids accidental changes being made to the wash cycles, especially where children are at home.



ECO indicator light: the **ECO** icon lights up when the electricity saving reaches at least 10% (this can be achieved by adjusting the wash cycle settings).

Running a wash cycle

GB

Note: the first time you use the washing machine, add detergent and run an empty 90°C cotton wash cycle without the pre-wash phase.

1. **SWITCH ON THE MACHINE.** Press the  button. All the indicator lights will illuminate for 1 second, after which the light corresponding to the  button will remain lit constantly, while the START/PAUSE indicator light will flash slowly.
2. **LOAD THE LAUNDRY.** Open the porthole door. Load the laundry, making sure that the maximum load quantity indicated in the table of programmes (below) is not exceeded.
3. **MEASURE OUT THE DETERGENT.** Pull out the drawer and pour the detergent into the relevant compartments as described in "Description of the machine".
4. **CLOSE THE PORTHOLE DOOR.**
5. **CHOOSE THE PROGRAMME.** Turn the PROGRAMME knob left or right to select the required programme, to which a set temperature and spin speed are linked (these values may all be modified).
6. **PERSONALISE THE WASH CYCLE.** Use the relevant buttons on the control panel:

 **Modify the temperature and/or the spin speed.** The machine automatically selects the temperature and the maximum spin speed for the programme set and these values may not be increased. By pressing the  button, the temperature can be progressively reduced or even set to cold wash (10). By pressing the  button, the spin speed can be progressively reduced or even eliminated altogether (10). If the buttons are pressed again the maximum values are restored.

! Exception: if the "WHITES" programme is selected, the temperature can be increased up to a value of 90°C.

 **Setting a delayed start.**
To set a delayed start for the selected programme, press the button repeatedly until the desired delay time is displayed (this may be between 1 hour and 24 hours).
To disable the function press the button until the text 10 is displayed.

N.B.: Once the button START/PAUSE has been pressed, the delay time may only be decreased.

 **Modify the cycle characteristics.**
Press the OPTION buttons to personalise the wash cycle according to your own requirements.

- Press the button to activate the option; the corresponding indicator light will illuminate.
- Press the button again to deactivate the option; the indicator light will switch off.

! If the selected option is not compatible with the set programme, the indicator light will flash and the option will not be activated.

! If the selected option is not compatible with another previously selected option, the indicator light corresponding to the first option will flash and only the second option will be activated (the corresponding indicator light will remain lit in a fixed manner).

7. **START THE PROGRAMME.** Press the START/PAUSE button. The corresponding indicator light remains lit in a fixed manner and the porthole door locks (the DOOR LOCKED indicator light illuminates). The icons corresponding to the different wash phases will light up during the cycle, indicating the progress. To change a programme while a cycle is in progress, **pause the washing machine** by pressing the START/PAUSE button; then select the desired cycle and press the START/PAUSE button again. To open the door while a cycle is in progress press the START/PAUSE button; if the DOOR LOCKED  indicator light switches off it is possible to open the door. Press the START/PAUSE button again to restart the programme from the point at which it was interrupted.
8. **PROGRAMME END.** The text END lights up to indicate that the programme has ended. The porthole door may be opened immediately. If the START/PAUSE button flashes, press the button to end the cycle. open the door, unload the laundry and switch off the machine.

! If you wish to cancel a cycle that has already begun, press and hold the  button. The cycle will be stopped and the machine will switch off.

BAG FOR QUILTS, CURTAINS AND DELICATE GARMENTS

Hotpoint has made it easier for you to wash even the most valuable and delicate garments in complete confidence thanks to the special bag which protects the laundry (this is supplied with the machine).

We recommend that the bag is used every time you wash **quilts and padded items with an outer layer made using synthetic material.**

Programmes and options

Table of Programmes

Icon	Programme description	Max. temperature (°C)	Max. spin speed (r.p.m.)	Detergent		Maximum load (kg)		Cycle duration			
				Washing	Fabric softener	Normal	Using Mini Load	Normal	Using Mini Load		
Everyday programmes											
	WHITES	60° (Max 90°)	1400	●	●	7.5	3.5	The wash cycle duration can be viewed on the display.			
	COLOURED S	40°	1400	●	●	7.5	3.5				
	SYNTHETICS 40°C	40°	800	●	●	3.5	1.5				
	FAST WASH: Refreshes lightly soiled garments quickly (not recommended for wool, silk or clothes that should be washed by hand).	30°	800	●	●	3.5	1.5				
Heavy Duty programmes											
	WHITE & PREWASH: Removes stubborn stains. <i>(Add detergent to the relevant compartment).</i>	90°	1400	●	●	7.5	3.5				
	SYNTHETICS 60°C	60°	800	●	●	3.5	1.5				
Special programmes											
	SHIRTS	40°	600	●	●	2	1				
	SILK: Washes silk and garments and lingerie.	30°	0	●	●	2	1				
	WOOL: Washes wool, cashmere, etc.	40°	600	●	●	2	1				
	DUVETS: Washes garments filled with goose down.	30°	1200	●	●	3	1,5				
	BED & BATH: Washes bathroom laundry and bedlinen.	60°	1400	●	●	7.5	3.5				
Rinse & Spin programmes											
	Cotton Rinse	-	1400	-	●	7.5	3.5				
	Delicate Rinse	-	800	-	●	3.5	1.5				
	Fast Spin	-	1400	-	-	7.5	3.5				
	Slow Spin	-	800	-	-	3.5	1.5				
	Pumpout	-	0	-	-	7.5	3.5				

The information contained in the table is purely indicative.

Wash options

Time Saver

Reduces the duration of the wash cycle, while making it possible to save water and electricity.

! It is not compatible with the "Mini Load" option and may not be enabled for the Fast Wash, Silk, Wool and Rinse & Spin programmes.

Reduced Creases

If this option is selected, the wash and spin phases will be adjusted accordingly so that fabric creasing is reduced. At the end of the cycle the drum of the washing machine will spin slowly; the "Reduced Creases" and START/PAUSE indicator lights will flash. To end the cycle, press the START/PAUSE button or the "Reduced Creases" button.

When using the **Silk** programme, the machine will end the cycle while the laundry is soaking and the "Reduced Creases" indicator light will flash. To drain the water so that the laundry can be removed, press the START/PAUSE button or the "Reduced Creases" button.

! This option is not compatible with the "Wool", "Fast Spin", "Slow Spin" and "Pumpout" programmes.

Extra Rinse

This programme increases the efficiency of the rinse phase and ensures that a greater amount of detergent is removed. It is particularly recommended for skin types that are sensitive to detergents. We recommend this programme is used when the washing machine is full or when a large amount of detergent has been used.

! This option is not compatible with the "Fast Wash", "Fast Spin", "Slow Spin" and "Pumpout" programmes.

Mini Load

This function should be used when the amount of laundry is half, or less than half, of the maximum recommended load (see *Table of Programmes*).

! This option is not compatible with "Time Saver" option and may not be enabled for the "Fast Spin", "Slow Spin" and "Pumpout" programmes.

Detergents and laundry

GB

Detergent

The type and quantity of detergent used depends on the type of fabric (cotton, wool, silk...), its colour, the temperature of the wash, the level of soiling and the hardness of the water in the area.

Measuring out the detergent carefully will avoid accidental spills and help to protect the environment: although they may be biodegradable, detergents contain elements that alter the balance of nature.

! Do not use detergents when washing garments by hand, because they create too much foam.

The detergent must be measured out into the relevant compartment, or into the detergent dosing ball which will be placed directly into the drum of the machine. In this case the Cotton cycle with pre-wash phase may not be selected.

Preparing the laundry

! Unfold all items of laundry before placing them in the machine.

- Divide the laundry according to type of material (the symbol on the garment label) and colour, making sure that whites are separated from coloured garments.
- Empty all pockets and check for loose buttons.
- Do not exceed the values indicated in the "Table of Programmes", which refer to the weight of the laundry items when they are dry.

How much does your laundry weigh?

1 sheet	400 - 500 g
1 pillowcase	150 - 200 g
1 tablecloth	400 - 500 g
1 bathrobe	900 - 1200 g
1 towel	150 - 250 g
1 pair of jeans	400 - 500 g
1 shirt	150 - 200 g

Washing advice

Shirts: use a suitable programme to wash shirts made from different fabrics and in different colours. This will guarantee that these garments are looked after properly.

Silk: use the relevant programme designed for all silk garments. We recommend the use of a special detergent for delicate garments.

Curtains: these should be folded and placed inside the bag provided. Use the "Silk" programme.

Wool: Hotpoint is the only washing machine to have obtained the prestigious Woolmark Platinum Care mark of recognition (M.0508) from The Woolmark Company, which certifies the machine washing of all woollen garments, even those whose label states "hand wash only"  (max. 1 kg). The "Wool" programme therefore offers you complete peace of mind when washing all woollen garments, with great performance guaranteed every time.

Duvets: to wash double or single duvets (the weight of which should not exceed 3 kg), cushions or clothes padded with goose down such as puffer jackets, use the special "Duvets" programme. We recommend that duvets are placed in the drum with their edges folded inwards (*see figure*) and that no more than $\frac{3}{4}$ of the total volume of the drum is used.

To achieve the best results, we recommend that a liquid detergent is used in conjunction with the detergent dispenser drawer.

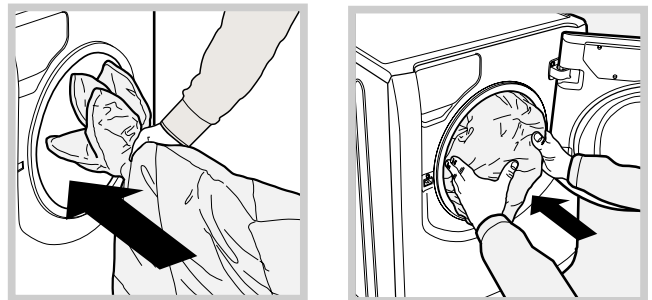

Quilts: to wash quilts with a synthetic outer layer, use the bag provided and set the programme to "Duvets".

Bathroom laundry and bedlinen: this washing machine can be used to wash any domestic laundry in a single cycle called "Bed & Bath" that optimises the use of fabric softener while saving both time and electricity. We recommend that you use a powder detergent.

Stubborn stains: stubborn stains should be treated with solid soap before the garment is washed (use the Cotton programme with pre-wash phase).

Load-balancing system

Before every spin cycle, to avoid excessive vibrations and to distribute the load in a uniform manner, the drum rotates continuously at a speed which is slightly faster than the normal washing speed. If, after several attempts, the load is still not evenly distributed, the machine spins at a lower speed than the set frequency. If the load is excessively unbalanced, the washing machine continues at distribution speed only instead of the full spin speed.

In order to achieve better load distribution and balance, we recommend that large and small garments are mixed when placing the laundry in the machine.

! This machine was designed and manufactured in compliance with current international safety standards. The following advice is provided for safety reasons and should be read carefully.

General safety

- This appliance was designed for domestic use inside the home and is not intended for commercial or industrial use.
- The washing machine must be used by adults only, in accordance with the instructions provided in this booklet.
- Do not touch the machine when barefoot or with wet or damp hands or feet.
- When unplugging the appliance, always pull the plug from the mains socket; do not pull on the cable.
- Do not touch the drained water as it may reach extremely high temperatures.
- Never force the porthole door: doing so may damage the safety lock mechanism designed to prevent the door being opened accidentally.
- If the appliance breaks down, under no circumstances must you attempt to carry out the repairs yourself.
- Keep children well away from the machine while it is in operation.
- If the machine must be moved, work in a group of two or three people and handle it very carefully. Never attempt to move the appliance without the help of another person, because it is extremely heavy.
- Make sure that the drum is empty before loading laundry into the appliance.

Disposal

- When disposing of the packaging material: observe local legislation so that the packaging may be reused.
- The European Directive 2002/96/EC relating to Waste Electrical and Electronic Equipment states that household appliances should not be disposed of using the normal solid urban waste cycle. Exhausted appliances should be collected separately in order to optimise the cost of re-using and recycling the materials inside the machine, while preventing potential damage to the atmosphere and to public health. The crossed-out dustbin is marked on all products to remind the owner of their obligations regarding separated waste collection.

For more information relating to the correct disposal of household appliances, owners should contact their local authorities or appliance dealer.

Opening the door manually

If it is not possible to open the porthole door due to a powercut and you wish to hang out the laundry, proceed as follows:

GB

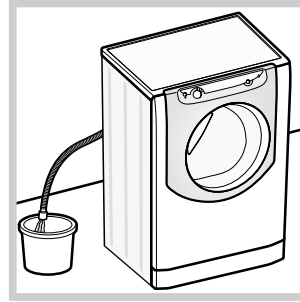

1. Remove the plug from the electricity socket;
2. Make sure that the water level inside the machine is lower than the door opening; if this is not the case remove excess water using the water outlet hose, collecting it in a bucket as shown in the *figure*;

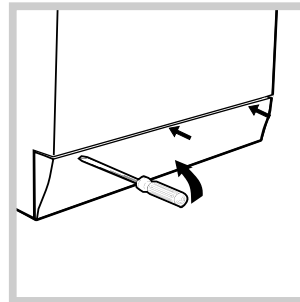

3. Remove the covering panel on the front of the washing machine using a screwdriver (*see figure*);

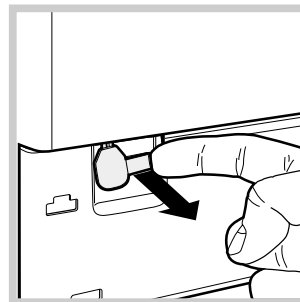

4. Using the tab shown in the figure, pull outwards until the plastic brace comes away; pull it downwards until you hear a "click", which indicates that the door is unlocked;

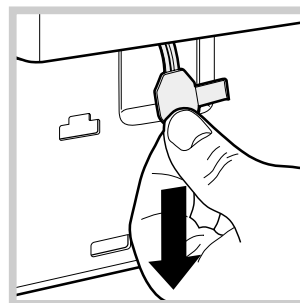

5. Open the door; if this is still not possible, repeat the process;

6. Replace the kick strip, making sure that the hooks are positioned in the right slots before pushing the panel towards the machine.

Care and maintenance

GB

Turning off the water and electricity supplies

- Turn off the water tap after every wash. This limits wear and tear on the machine's water supply and prevents leaks.
- Disconnect the appliance from the electricity supply before cleaning it and before performing any maintenance work on it.

Cleaning the machine

The exterior of the appliance and all rubber parts may be cleaned using a cloth soaked in warm soapy water. Do not use solvents or abrasive products.

Cleaning the detergent dispenser drawer

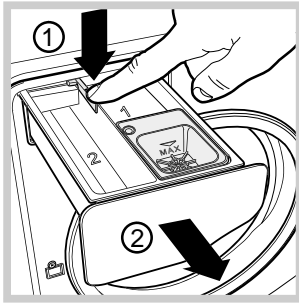

To remove the drawer, press the lever (1) and pull it outwards (2) (*see figure*). Wash the drawer under running water; this should be done regularly.

Drum maintenance

- Always leave the porthole door ajar to prevent unpleasant odours from forming.

Cleaning the pump

The washing machine is fitted with a self-cleaning pump which does not require regular maintenance. However, it may be that small objects (coins, buttons, etc.) fall into the pre-chamber that protects the pump (the pump is located in the lower part of this pre-chamber).

! Make sure that the wash cycle has finished and remove the plug from the socket.

To access the pre-chamber:

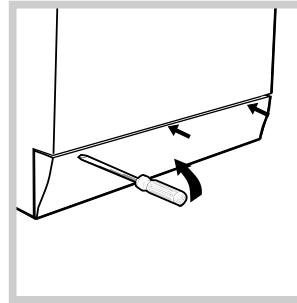

1. Remove the kick strip on the front of the machine using a screwdriver (*see figure*);

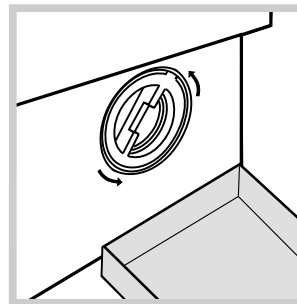

2. Position a container collecting the drained water (approximately 1.5 l) correctly (*see figure*);
3. Unscrew the cover, turning it in an anticlockwise direction (*see figure*);

4. Clean the inside thoroughly;
5. Screw the cover back on;
6. Replace the kick strip, making sure that the hooks are positioned in the right slots before pushing the panel towards the machine.

Checking the water inlet hose

Check the water inlet hose at least once a year. If there are any cracks, replace it immediately: the high water pressure used by the wash cycles could cause a cracked hose to split open.

From time to time your machine may not operate as it should. Before calling for Assistance (*see "Assistance"*), make sure that the problem cannot be resolved easily using the following list.

Malfunction:

The washing machine will not switch on.

The wash cycle does not begin.

The washing machines fails to fill with water.

The machine continuously fills and drains water.

The machine does not drain or spin.

The washing machine vibrates too much during the spin cycle.

The washing machine leaks.

The icons corresponding to the "Phase in progress" flash rapidly at the same time as the ON/OFF indicator light.

There is too much foam.

The washing machine door remains locked.

Possible causes / Solutions:

- The plug has not been inserted into the electrical socket, or it has not been inserted far enough to make contact.
- There is no power in the house.

- The porthole door has not been shut properly.
- The START/PAUSE button has not been pressed.
- The water tap has not been turned on.

- The water inlet hose is not connected to the tap.
- The hose is kinked.
- The water tap has not been turned on.
- There is no water in the house.
- The water pressure is insufficient.
- The START/PAUSE button has not been pressed.

- The end of the outlet hose has not been fitted at a height between 65 and 100 cm from the floor (*see "Installation"*).
- The free end of the hose is underwater (*see "Installation"*).
- If the dwelling is on one of the upper floors of a building, there may be problems relating to water drainage, causing the washing machine to load and drain water continuously. Special anti-draining valves are available in shops and help to avoid this inconvenience.
- The water drainage system is not fitted with a breather pipe.

- The programme does not include a draining phase: some programmes require manual draining (*see "Programmes and options"*).
- The "Reduced Creases" option is enabled: to complete the programme, press the START/PAUSE button (*see "Programmes and options"*).
- The outlet hose is bent (*see "Installation"*).
- The drainage duct is clogged.

- The drum was not unlocked properly when the appliance was installed (*see "Installation"*).
- The washing machine is not level (*see "Installation"*).
- The washing machine is trapped between cabinets and a wall (*see "Installation"*).
- The load is not balanced properly (*see "Description of the machine"*).

- The water inlet hose is not screwed on to the tap correctly (*see "Installation"*).
- The detergent dispenser drawer is blocked (for instructions on how to clean it, *see "Care and maintenance"*).
- The outlet hose has not been secured properly (*see "Installation"*).

- Switch off the machine and unplug the appliance; wait for approximately 1 minute then switch it on again. If the problem persists, contact Assistance.

- The detergent is not designed for machine washing (the packaging should state that the product is "for washing by machine", "for washing by hand or machine" or similar).
- Too much detergent was used.

- Follow the manual unlocking procedure (*see "Precautions and tips"*).

! If the problem persists after the above checks have been carried out, shut off the water tap, switch off the machine and contact Assistance.

Guarantee

12 Months Parts and Labour Guarantee

Your appliance has the benefit of our manufacturer's guarantee, which covers the cost of breakdown repairs for twelve months from the date of purchase.

This gives you the reassurance that if, within that time, your appliance is proven to be defective because of either workmanship or materials, we will, at our discretion, either repair or replace the appliance at no cost to you.

This guarantee is subject to the following conditions:

- The appliance has been installed and operated correctly and in accordance with our operating and maintenance instructions.
- The appliance is used only on the electricity or gas supply printed on the rating plate.
- The appliance has been used for normal domestic purposes only.
- The appliance has not been altered, serviced, maintained, dismantled, or otherwise interfered with by any person not authorised by us.
- Any repair work must be undertaken by us or our appointed agent.
- Any parts removed during repair work or any appliance that is replaced become our property.
- The appliance is used in the United Kingdom or Republic of Ireland.

The guarantee **does not cover:**

- Damage resulting from transportation, improper use, neglect or interference or as a result of improper installation.
- Replacement of any consumable item or accessory. These include but are not limited to: plugs, cables, batteries, light bulbs, fluorescent tubes and starters, covers and filters.
- Replacement of any removable parts made of glass or plastic.

THIS GUARANTEE WILL NOT APPLY IF THE APPLIANCE HAS BEEN USED IN COMMERCIAL OR NON-DOMESTIC PREMISES.

5 Year Parts Guarantee

Hotpoint also offers you a free 5 year parts guarantee. This additional guarantee is conditional on you registering your appliance with us and the parts being fitted by one of our authorised engineers.

There will be a charge for our engineer's time. To activate the extra parts warranty on your appliance, simply call our registration line on **0870 6092094 (ROI 01 230 0800)**.

Extended Guarantees

We offer a selection of repair protection plans that enable you to fully cover yourself against the expense of repair bills for the life of your policy. To find the ideal plan for you please call our advice line on **08709 088 088 (ROI 01 230 0233)**.

Free Helpdesk Service

We have a dedicated team who can provide free advice and assistance with your appliance if you experience any technical difficulties within the first 90 days of ownership. Simply call our Hotpoint Service Hotline on **08709 066 066 (ROI 0818 313 413)** for telephone assistance, or, where necessary, to arrange for an engineer to call. If we cannot resolve the technical problem we will replace your machine or, if you prefer, give you your money back.

After Sales Service

No one is better placed to care for your Hotpoint appliance during the course of its working life than us - the manufacturer.

Essential Contact Information

Hotpoint Service

We are the largest service team in Europe offering you access to 400 skilled telephone advisors and 1100 fully qualified engineers on call to ensure you receive fast, reliable, local service.

UK: 08709 066 066
Republic of Ireland: 0818 313 413
www.hotpointservice.co.uk

Please note: Our advisors will require the following information:

Model number:

Serial number:

Parts and Accessories

We supply a full range of genuine replacement parts as well as accessory products that protect and hygienically clean your appliance to keep it looking good and functioning efficiently throughout its life.

UK: 08709 077 077
Republic of Ireland: 0818 313 413
www.hotpointservice.co.uk

Appliance Registration

We want to give you additional benefits of Hotpoint ownership. To activate your free 5 year parts guarantee you must register your appliance with us.

UK: 0870 6092094
Republic of Ireland: 01 230 0800
www.hotpointservice.co.uk

Indesit Company UK Ltd. Morley Way, Peterborough, PE2 9JB

Indesit Company Unit 49 Airways Industrial Estate, Dublin 17



Recycling & Disposal Information

As part of Hotpoint's continued commitment to helping the environment, Hotpoint reserves the right to use quality, recycled components to keep down customer costs and minimise material waste.

Please dispose of packaging and old appliances carefully. To minimise the risk of injury to children, remove the door, plug and cut the mains cable off flush with the appliance. Dispose of these parts separately to ensure that the appliance can no longer be plugged into a mains socket, and the door cannot be locked shut.

